

# Computability

voorjaar 2021

<https://liacs.leidenuniv.nl/~vlietrvan1/computability/>

college 1, 4 februari 2021

## 7. Turing Machines

7.1. A General Model of Computation

7.2. Turing Machines as Language Acceptors

# Praktische Informatie

- docent: Rudy van Vliet, kamer 140 Snellius, rrvliet@liacs.nl
- hoorcollege: donderdag, 11.15–13.00 (weblecture)  
werkcollege:  
vrijdag, 14.15–15.00 (weblecture)  
vragenuur:  
vrijdag, 15.15–16.00 (online, Kaltura)  
van 4 februari – 19 maart 2021
- boek: John C. Martin, Introduction to Languages and the Theory of Computation, 4th edition (verkrijgbaar?)
- hoofdstuk 7–9 (deels)
- dictaat (voorkennis)

# Praktische Informatie

- tentamens (on campus):

vrijdag 26 maart 2021, 09.00–12.00

donderdag 27 mei 2021, 09.00–12.00

- Eén huiswerkopgave (individueel)

Niet verplicht, maar ...

eindcijfer = tentamencijfer + cijferhuiswerkopgave

cijferhuiswerkopgave  $\leq 0.4$

eindcijfer  $\leq 10.0$

- 3 EC

# Praktische Informatie

Website

<https://liacs.leidenuniv.nl/~vlietrvan1/computability/>

- weblectures (tijdelijk)
- slides, N.B.....
- overzicht van behandelde stof
- antwoorden van bepaalde opgaven
- huiswerkopgave
- errata

# Overview

7. Turing machines

8. Recursive(ly enumerable) languages / general grammars

9. Undecidable problems

# Automata Theory

reg. languages	FA	reg. grammar	reg. expression
determ. cf. languages	DPDA		
cf. languages	PDA	cf. grammar	

# Aut. Theory: Pumping Lemma for CFLs

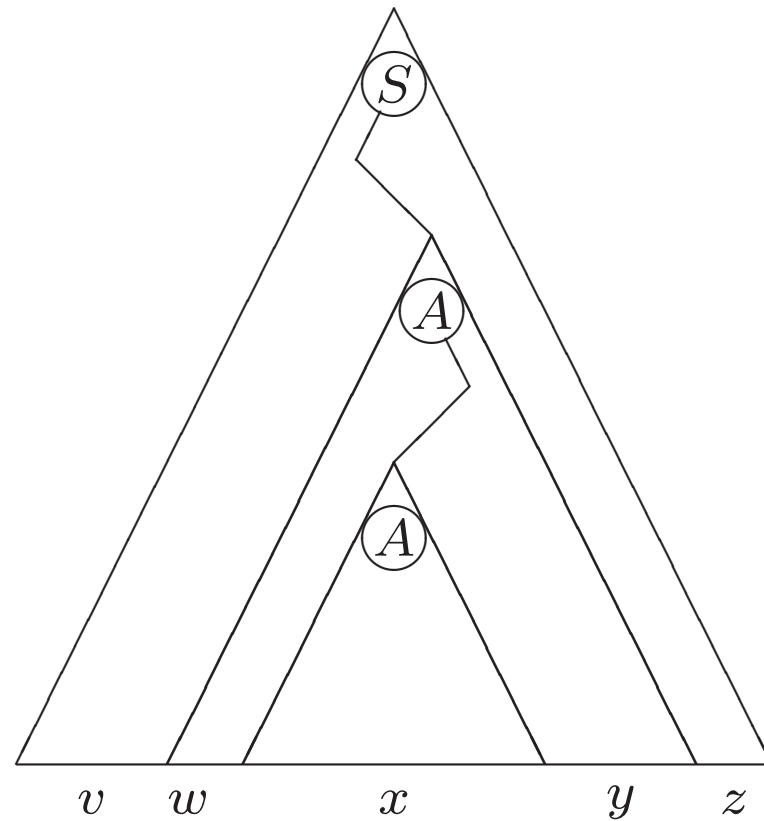

# Aut. Theory: Pumping Lemma for CFLs

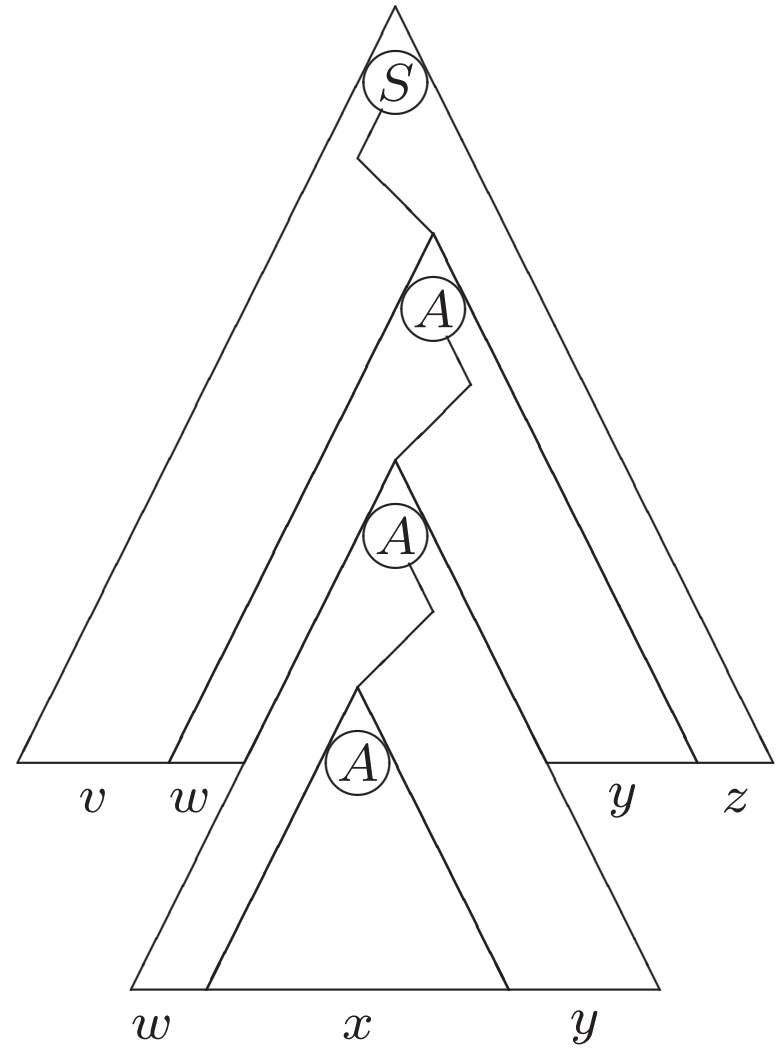
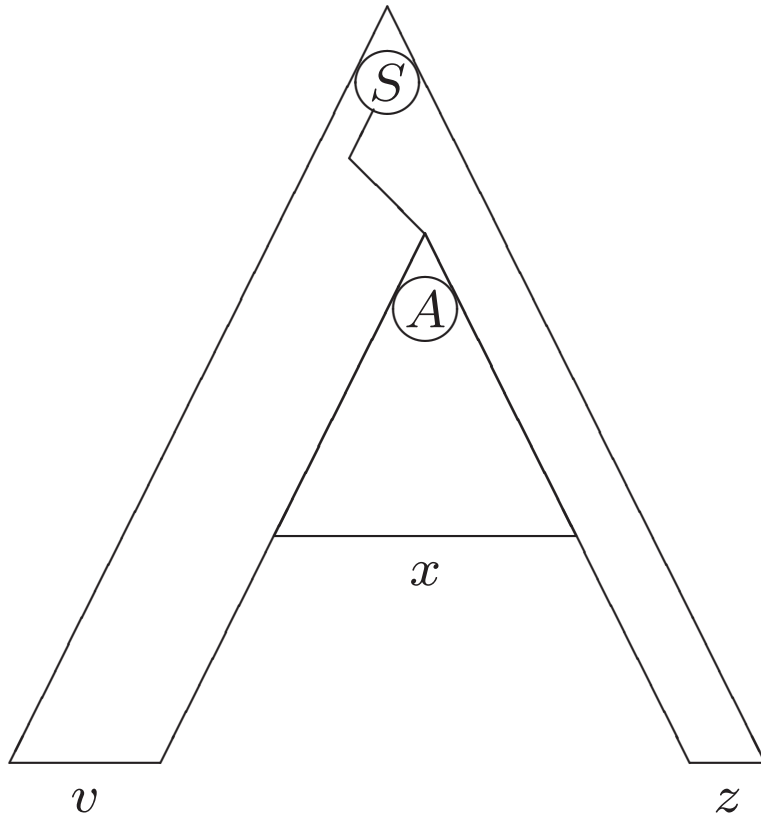



## 7. Turing Machines

reg. languages	FA	reg. grammar	reg. expression
determ. cf. languages	DPDA		
cf. languages	PDA	cf. grammar	
cs. languages	LBA	cs. grammar	
re. languages	TM	unrestr. grammar	

## 7.1. A General Model of Computation

$$AnBnCn = \{a^i b^i c^i \mid i \geq 0\}$$

$$L = \{xcx \mid x \in \{a, b\}^*\}$$

**Assumptions about a human computer  
working with a pencil and paper:**

1. The only things written on the paper are symbols from some fixed finite alphabet;
2. Each step taken by the computer depends only on the symbol he is currently examining and on his “state of mind” at the time;
3. Although his state of mind may change as a result of his examining different symbols, only a finite number of distinct states of mind are possible.

## **Actions of a human computer on a sheet of paper:**

1. Examining an individual symbol on the paper;
2. Erasing a symbol or replacing it by another;
3. Transferring attention from one symbol to another nearby symbol.

## Turing machine

Turing machine has a finite alphabet of symbols.

(actually two alphabets. . .)

Turing machine has a finite number of states.

Turing machine has a *tape*

for reading input,

as workspace,

and for writing output (if applicable).

Tape is linear, instead of 2-dimensional.

Tape has a left end and is potentially infinite to the right.

Tape is marked off into squares, each of which can hold one symbol.

Tape head is centered on one square of the tape for reading and writing.

## **A move of a Turing machine consists of:**

1. Changing from the current state to another, possibly different state;
2. Replacing the symbol in the current square by another, possibly different symbol;
3. Leaving the tape head on the current square, or moving it one square to the right, or moving it one square to the left if it is not already on the leftmost square.

## **Just like FA and PDA, Turing machine**

- may be used to accept a language
- has a finite number of states

## **Just like FA, but unlike PDA**

- by default TM is deterministic

## **Unlike FA and PDA, Turing machine**

- may also be used to compute a function \*
- is not restricted to reading input left-to-right \*
- does not have to read all input \*
- does not have a set of accepting states, but has two *halt* states: one for acceptance and one for rejection (in case of computing a function, ...)
- might not decide to halt

\* = just like human computer

## Example.

An FA Accepting  $L = \dots$

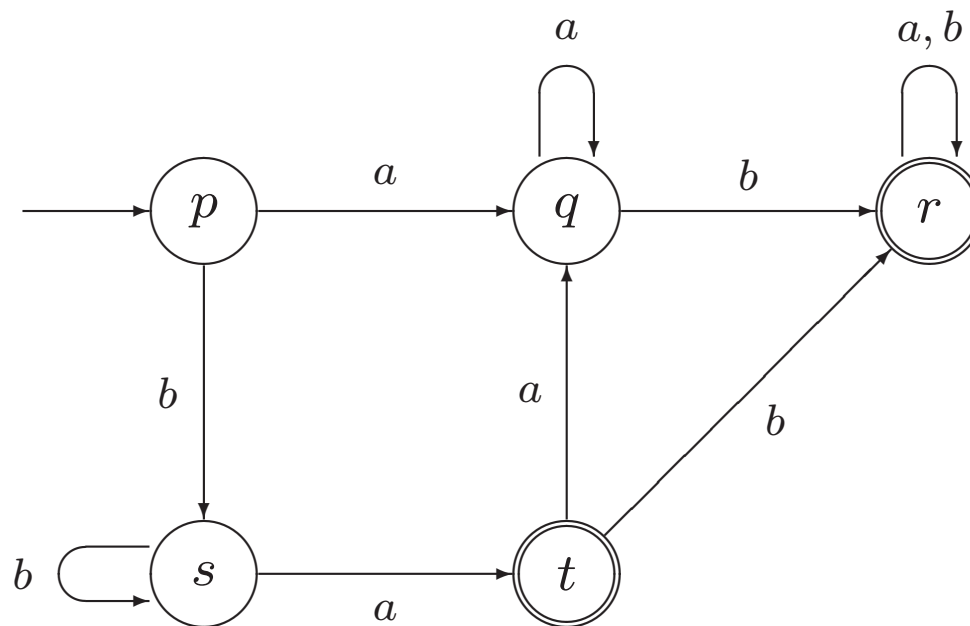



## Example.

An FA Accepting  $L = \{a, b\}^* \{ab\} \{a, b\}^* \cup \{a, b\}^* \{ba\}$

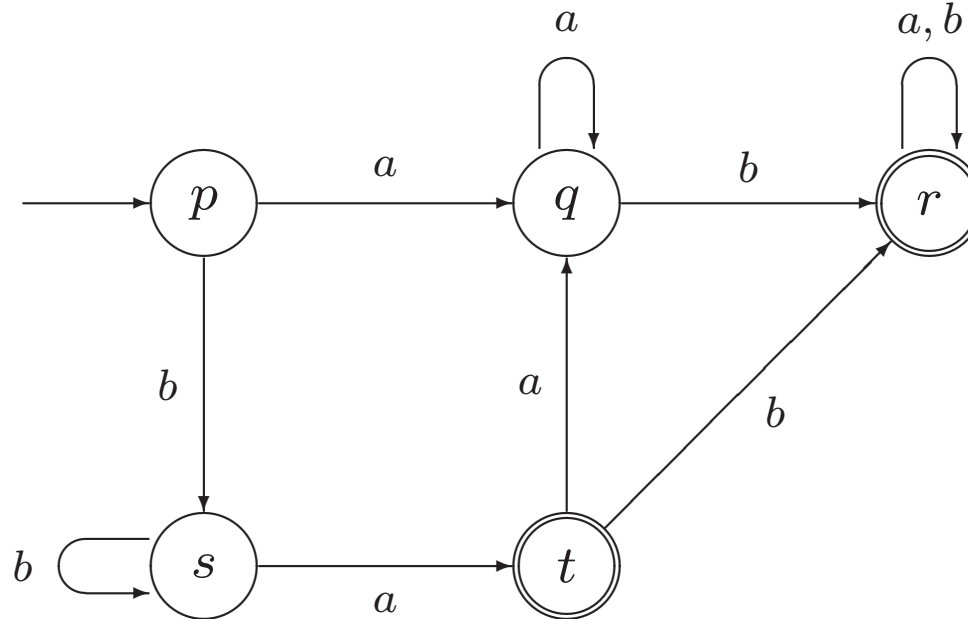

Why two accepting states?

## 7.2. Turing Machines as Language Acceptors

**Example 7.3.** A TM Accepting a Regular Language

$$L = \{a, b\}^* \{ab\} \{a, b\}^* \cup \{a, b\}^* \{ba\}$$

First a finite automaton:

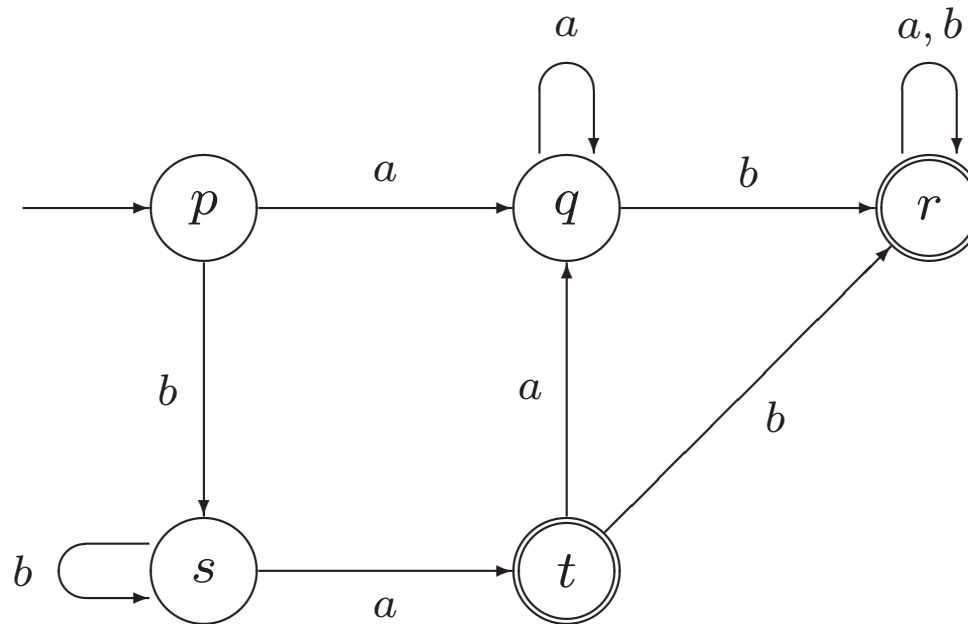

### Example 7.3. A TM Accepting a Regular Language

$$L = \{a, b\}^* \{ab\} \{a, b\}^* \cup \{a, b\}^* \{ba\}$$

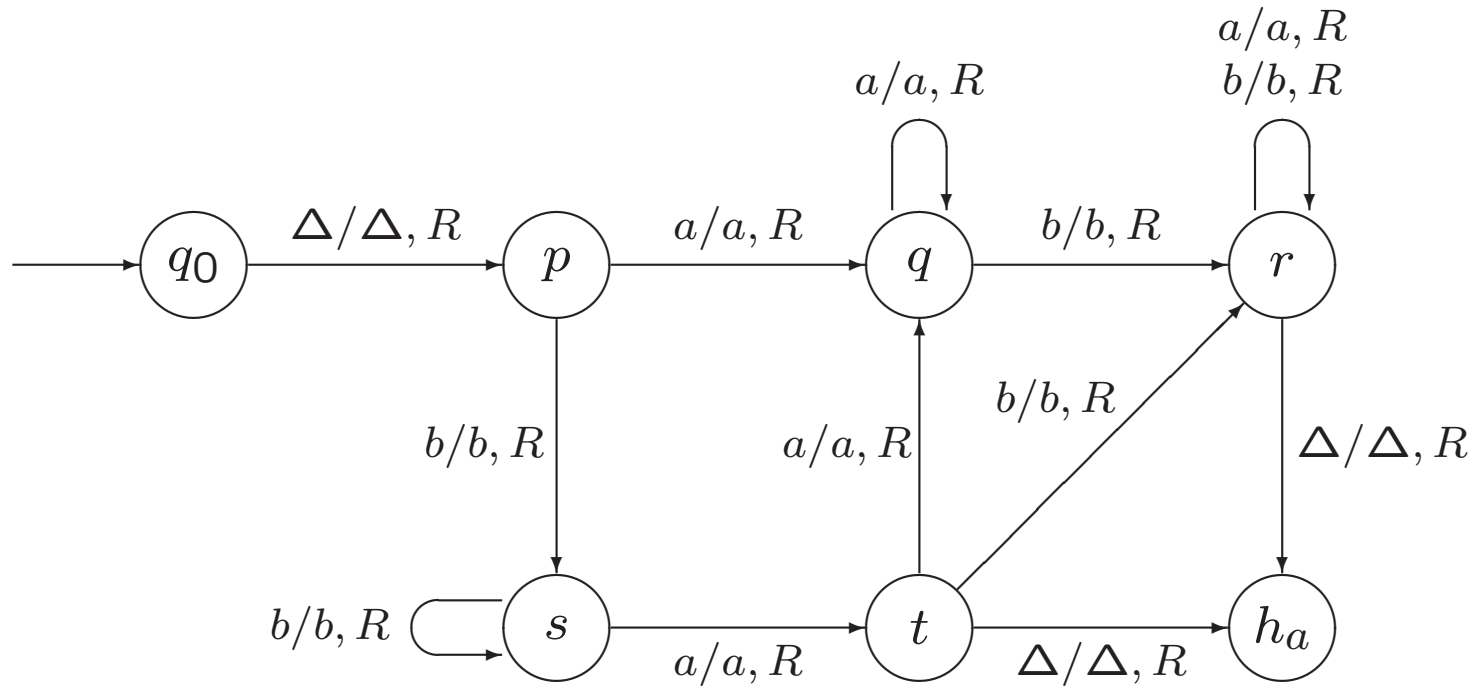

$\Delta$  vs  $\Lambda$

$\Lambda$  vs  $\{\Lambda\}$  vs  $\emptyset$

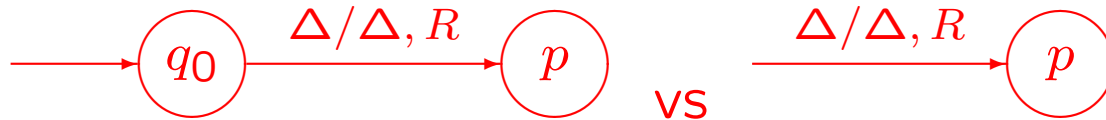

### Example 7.3. A TM Accepting a Regular Language

$$L = \{a, b\}^* \{ab\} \{a, b\}^* \cup \{a, b\}^* \{ba\}$$

First a finite automaton, then a Turing machine

This conversion works in general for FAs.

As a result,

- only moves to the right,
- no modifications of symbols on tape,
- no moves to the reject state, but ...

In this case,

- we could modify TM, so that it does not always read entire input.

**Example 7.5.** A TM Accepting  $XX = \{xx \mid x \in \{a, b\}^*\}$

$\Delta$ *aabaab*

...

**Example 7.5.** A TM Accepting  $XX = \{xx \mid x \in \{a, b\}^*\}$

$\underline{\Delta} a a b a a b$

$\Delta A a b a a b$

$\Delta A a b a a B$

$\Delta A A b a a B$

$\Delta A A b a A B$

$\Delta A A B a A B$

$\Delta A A B A A B$

...

**Example 7.5.** A TM Accepting  $XX = \{xx \mid x \in \{a, b\}^*\}$

$\underline{\Delta} a a b a a b$   
 $\Delta A a b a a b$   
 $\Delta A a b a a B$   
 $\Delta A A b a a B$   
 $\Delta A A b a A B$   
 $\Delta A A B a A B$   
 $\Delta A A B A A B$   
 $\Delta a a b A A B$   
 $\Delta A a b A A B$   
...

**Example 7.5.** A TM Accepting  $XX = \{xx \mid x \in \{a, b\}^*\}$

$\underline{\Delta} a a b a a b$   
 $\Delta A a b a a b$   
 $\Delta A a b a a B$   
 $\Delta A A b a a B$   
 $\Delta A A b a A B$   
 $\Delta A A B a A B$   
 $\Delta A A B A A B$   
 $\Delta a a b A A B$   
 $\Delta A a b A A B$   
 $\Delta A a b \Delta A B$   
 $\Delta A A b \Delta A B$   
 $\Delta A A b \Delta \Delta B$   
 $\Delta A A B \Delta \Delta B$   
 $\Delta A A B \Delta \Delta \Delta$



**Example 7.5.** A TM Accepting  $XX = \{xx \mid x \in \{a, b\}^*\}$

$\underline{\Delta} a a b a a b$   
 $\Delta A a b a a b$   
 $\Delta A a b a a B$   
 $\Delta A A b a a B$   
 $\Delta A A b a A B$   
 $\Delta A A B a A B$   
 $\Delta A A B A A B$   
 $\Delta a a b A A B$   
 $\Delta A a b A A B$   
 $\Delta A a b \Delta A B$   
 $\Delta A A b \Delta A B$   
 $\Delta A A b \Delta \Delta B$   
 $\Delta A A B \Delta \Delta B$   
 $\Delta A A B \Delta \Delta \Delta$

What if input  $w \notin XX$ ?

$T$  **decides** on membership of  $XX$